

GS220130

Included accessories

1 x wire rack
1 x cooking insert perforated
1 x cooking insert unperforated

Optional accessories

BA046118:

Glass tray 60cm

BA220360:

Container st. steel unperf for BSP22*

BA220370:

Container st. steel perf for BSP22*

GN114130:

GN insert unperf, st. steel, GN1/3, 40mm

GN114230:

GN insert unperf, st. steel, GN2/3, 40mm

GN124130:

GN insert perf, st. steel, GN1/3, 40mm

GN124230:

GN insert perf, st. steel, GN2/3, 40mm

installation accessories

GA601010:

Adjustable intermediate shelf 60cm

Steam oven Gaggenau Minimalistic series
60 x 45 cm, door hinge: right

GS220130

- Full-size side-hinged door with one-touch opening for easy, ergonomic access
- Seamless interface design with refined aesthetics, featuring a floating stainless steel ring and haptic feedback

Highlights

Flush installation.

Handleless full glass door with electronic door opening.

Full touch display with stainless steel control ring.

Light and display response upon user approach.
Water tank for fresh water for flexible installation.

External steam generation to avoid limescale in the cooking compartment.

Steaming with 100% humidity from 30 °C to 100 °C.

Sous-vide cooking with accurate temperature regulation.

Setting recommendations.

Net volume 59 litres.

Heating methods / Programmes

100 % humidity.

Sous-vide cooking.

Low temperature steaming.

Dough proving.

Defrosting.

Regenerating.

130 setting recommendations.

Option to save up to 30 favourites.

Handling

Cushioned side-opening door with 110 ° opening angle.

Electronic door opening.

Full touch display with control ring.

42 display languages available.

User detection, adjustable distance.

Info texts for additional information.

Animated quick guides to assist appliance operation.

Features

1 removable 1.7 litres water tank, dishwasher-safe.

Water level warning.

Automatic boiling point detection.

Precise temperature control with display of the current temperature.

Timer functions: cooking time, cooking time end, count-up timer.

Programmable automatic door opening at cooking time end to avoid overcooking.

Optimum visibility of the food thanks to side lighting.

3 shelf levels.

Selected digital services (Gaggenau Home Connect)

Remote control and monitoring.

Software updates.

Door opening via voice assistant.

Safety

Child lock to prevent accidental switch on or operation of the appliance.

Electronic door lock to prevent unintentional opening of the appliance door.

Safety shut-off.

Thermally insulated door with triple glazing.

Cooled housing with temperature protection.

Cleaning

Hygienic stainless steel cooking interior.

Cleaning aid.

Automatic descaling for the steam generator.

All removable parts and accessories

dishwasher-safe, incl. water tank.

Planning notes

Plan the niche without back wall.

Door hinge not reversible.

No other electrical appliances should be installed above the GS.

Protrusion from appliance front to furniture cabinet 21 mm.

This appliance is intended for front flush installation.

No protruding front panel, horizontal handle, high cabinet top etc. should be fitted directly above the steam oven to prevent damage to the furniture.

The edge of a worktop must be steam resistant as is required above a dishwasher.

When planning a corner solution, pay attention to the side-opening door and the minimum required distance to the wall.

Door opening angle appr. 110° (delivery status) can be reduced to appr. 92° if required.

The mains socket must be accessible and located outside the built-in niche.

Special accessories (order as spare part):

Part No. 17002490 Descaling tablets.

Connection

Total connected load 2.8 KW.

Connection cable 1.75 m, pluggable.

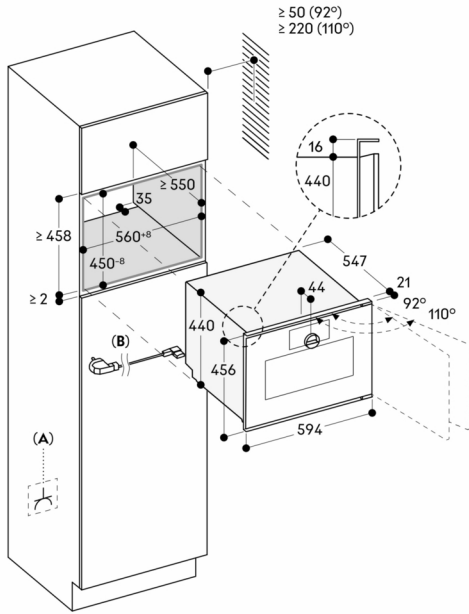

A: Accessible electrical connection
B: Cable with or without plug, depending on country

Measurements in mm